

AC Induction Motor Spur Gearbox Type ST90-5IK90



Motor Data

Model	Rated Power (W)	Rated Voltage (V)	Frequency (Hz)	Rated Current (A)	Starting Torque (mNm)	Rated Torque (mNm)	Rated Speed (min ⁻¹)	Capacitor (μF)
5IK90-AF	90	1ph 100	50 60	1.55 1.85	450	700 570	1250 1550	25.0
5IK90-EF	90	1ph 110 1ph 120	60	1.40 1.45	500	570	1550	20.0
5IK90-CF	90	1ph 220 1ph 230	50	0.72 0.70	450	700	1250	5.0
5IK90-HF	90	1ph 220 1ph 230	60	0.71 0.75	450	570	1550	5.0
5IK90-SF	90	3ph 220	50 60	0.60 0.55	1350 1100	700 570	1250 1550	–

Rel. Humidity: 20 bis 85% | Ambient Temp.: -10 bis +50 °C | Net Weight Motor max. 3.2 kg

Gearmotor Data (at 50 Hz)

Gear Ratio	3	3.6	5	6	7.5	9	10	12.5	15	18	20	25	30	36	40	50	60	75	90	100	120	150	180	200
Speed (min ⁻¹)	500	417	300	250	200	166	150	120	100	83	75	60	50	41	37	30	25	20	16	15	12.5	10	8.3	7.5
Rated Torque (Nm)	1.10	2.00	2.80	3.40	4.30	5.10	5.31	6.40	7.70	9.20	9.55	11.6	13.6	16.6	18.1	20.0	20.0	20.0	20.0	20.0	20.0	20.0	20.0	20.0

Radial Load (FR) from reduction 25: 1 (10 mm from face mounting): 500 N | Axial Load (FA): 150 N

Net Weight Gearbox max. 1.5 kg

Gearmotor

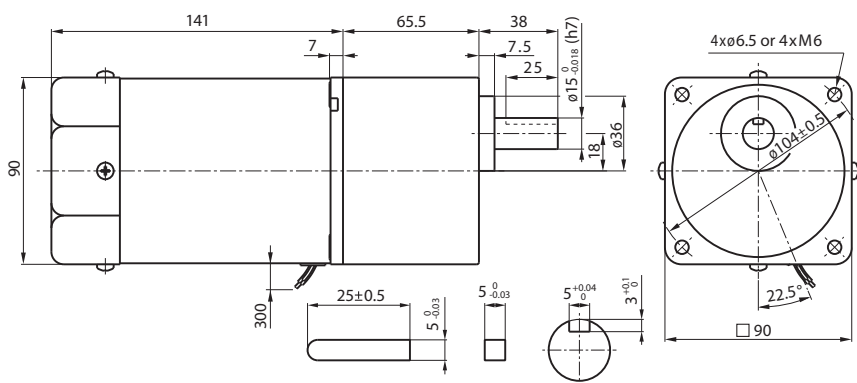

Motor

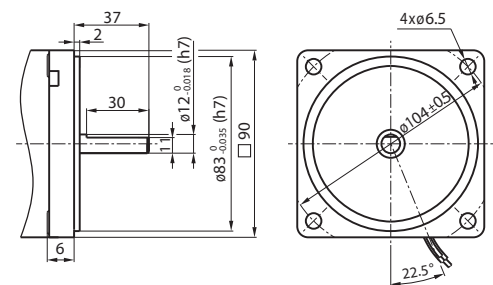

(As a gearmotor the motor shaft is with pinion included.)

Capacitor

Capacitance (μF)	L	W	H
5.0	47	20	31
20.0	47	23	35
25.0	47	27	37

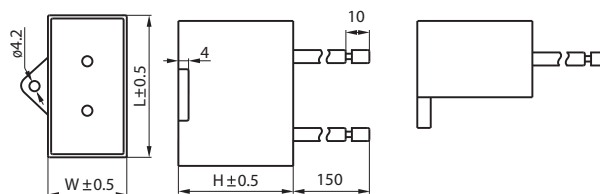

Options

Terminal Box
Worm Gearbox
Bevel Gearbox
Brake

Wiring Diagram: 5IK90-AF, 5IK90-EF, 5IK90-CF, 5IK90-HF

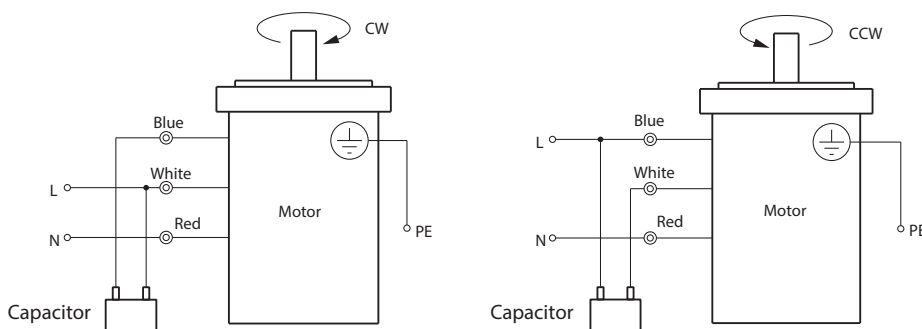

5IK90-SF

