

BLDC Motor Type BL28.50H

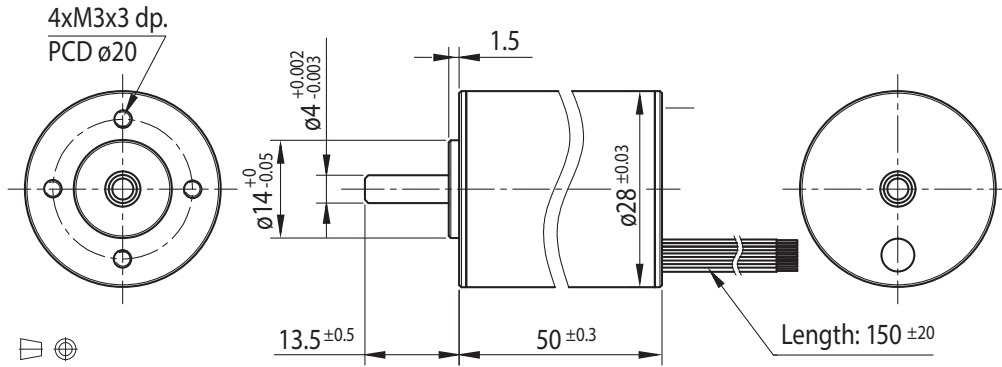
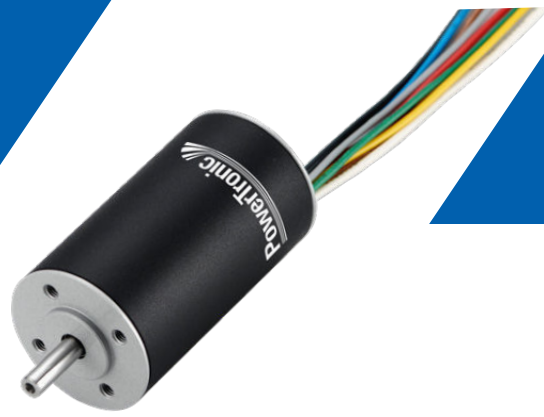

Pin No.	Colour	Function	Wire Spec
1	Red	U	UL1430 22AWG
2	Black	V	
3	White	W	
4	Blue	GND	UL1430 26AWG
5	Yellow	HU	
6	Brown	HV	
7	Gray	HW	
8	Green	+5V	

Motor

Rated Voltage (V)	Rated Torque (Ncm)	Rated Speed (min ⁻¹)	Rated Current (A)	No Load Speed (min ⁻¹)	No Load Current (A)	Rated Power (W)	Max. Efficiency (%)	Weight (g)
24	1.4	9100	1.85	9500	0.98	13	55	140

